

C39004

INSTALLATION INSTRUCTIONS SHEET

START FROM HERE

- Make sure power is completely off at the fuse box.
- Have your fixture installed by a qualified licensed electrician
- Prepare everything in clear area.
- Wear gloves at all times during this installation.
- Read instructions carefully before you start assembly.
- Keep this instruction sheet for future reference.

Technical Support: 1-844-628-8368

Please Note:

- All Matteo Lighting fixtures come with pre-wired module(s).
- Unless instructed to do so, please do not touch any part of the module(s) as unnecessary contact with the module could cause permanent damage.

THIS LUMINAIRE MUST BE MOUNTED OR SUPPORTED IN A JUNCTION BOX
*CE LUMINAIRE DOIT ÊTRE MONTÉ OU SUPPORTÉ DANS UNE BOÎTE
DE JONCTION*

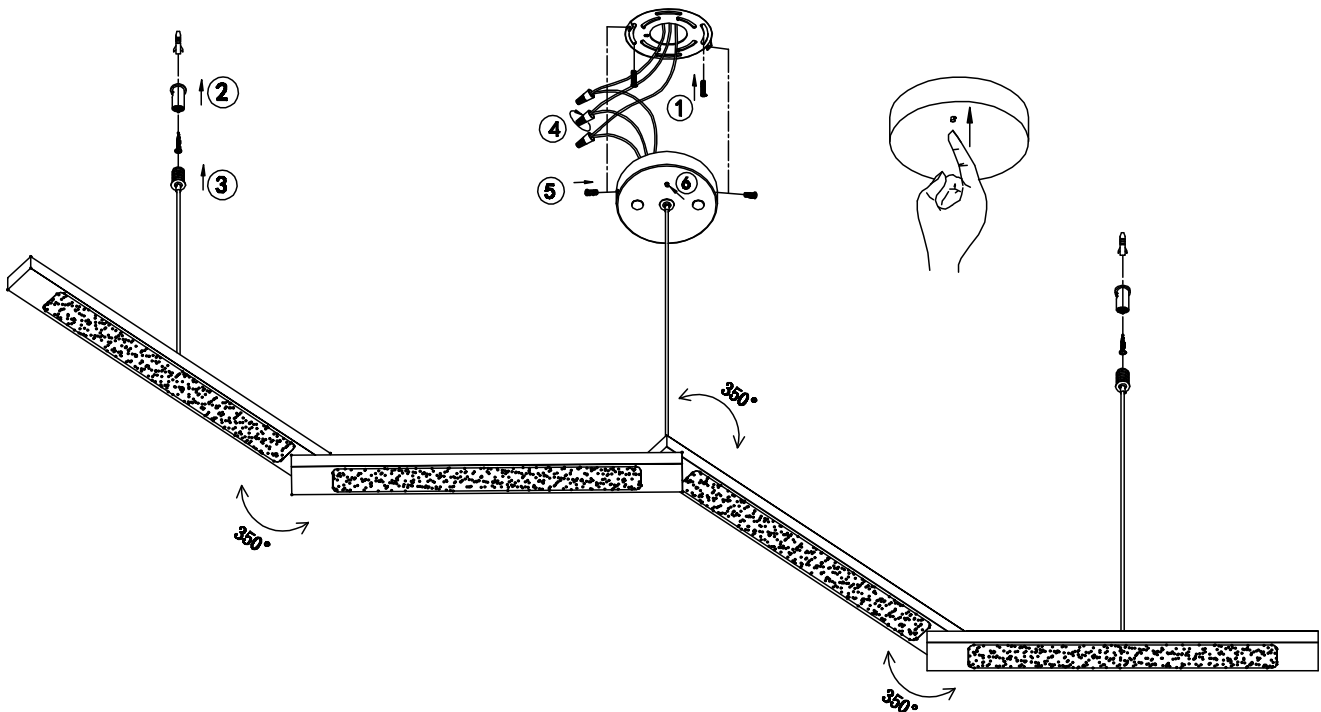
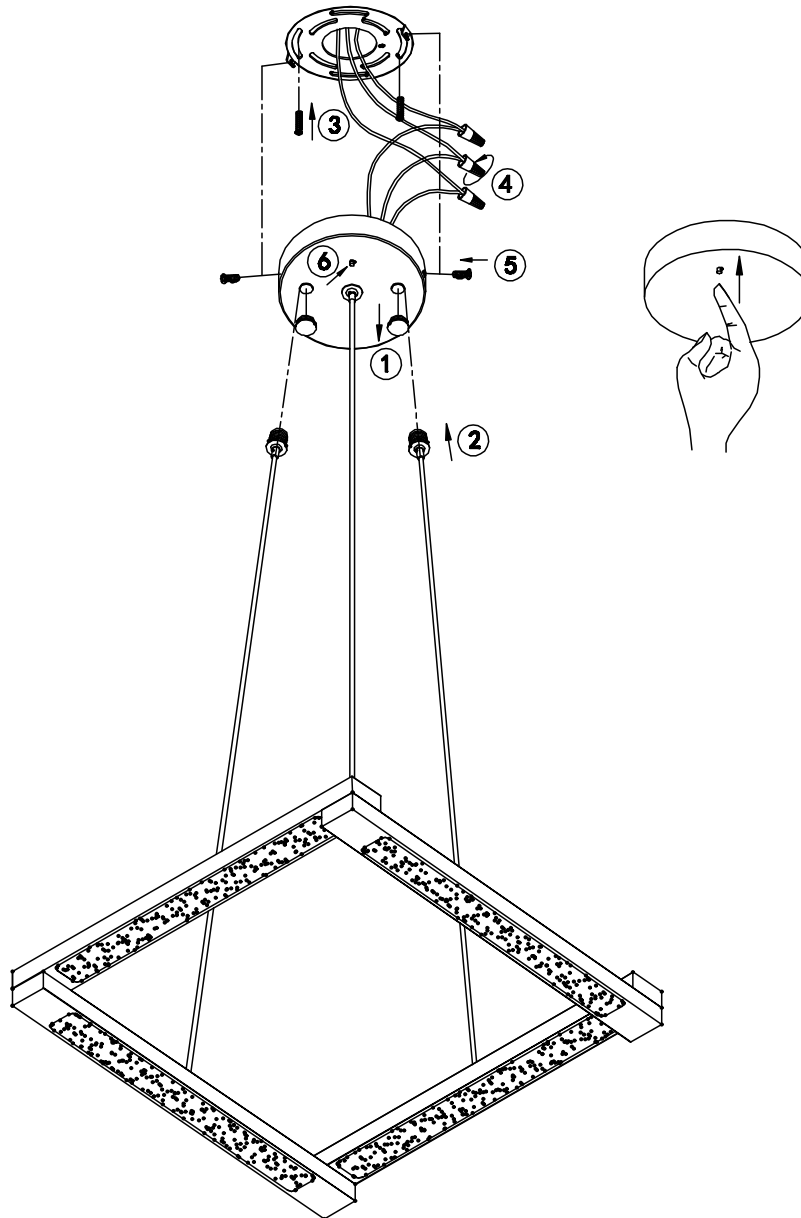

ILLUSTRATION 1

- Ensure main supply is switched off.
- Fit mounting plate to electrical junction box using junction box screws provided in accessory bag (1).
- Secure the aircraft barrel to the mounting surface using anchors and screws. Adjust the cable to your desired length and secure it with a set screw (2,3)
- Connect wires (4) according to color (White to White, Black to Black). Connect all earth lug together onto the crossbar with green screw to tight.
- Fit canopy onto mounting plate (5)
- Select your desired color temperature by pressing the button. (6)
- Reconnect power.
- Light source: DC LED 4*10W, 5CCT:2700K/3000K/3500K/4000K/5000K,CRI90, TRIAC dimming

ILLUSTRATION 2



- Ensure main supply is switched off.
- Remove the plugging accessories from the ceiling plate (1).
- Secure the aircraft barrel to the mounting surface with screws. (2)
- Fit mounting plate to electrical junction box using junction box screws provided in accessory bag (3)
- Connect wires (4) according to color (White to White, Black to Black). Connect all earth lug together onto the crossbar with green screw to tight.
- Fit canopy onto mounting plate (5)
- Select your desired color temperature by pressing the button. (6)
- Reconnect power.
- Light source: DC LED 4*10W, 5CCT:2700K/3000K/3500K/4000K/5000K,CRI90,TRIAC dimming

WARNING:

- This fitting must be earthed.
- Disconnect power and allow fitting to cool down before cleaning or changing the lamp.